

FPGA4UMUBUS

LAP R.Beuchat
Phone: +41 21 693 3903
Fri Dec 8 15:17:00 MET 2006

MFG_DATE: 11.12.2006
QUANTITY: 30
SOLDERMASK: mtop mbot
MATERIAL: FR4 : 1.6 mm

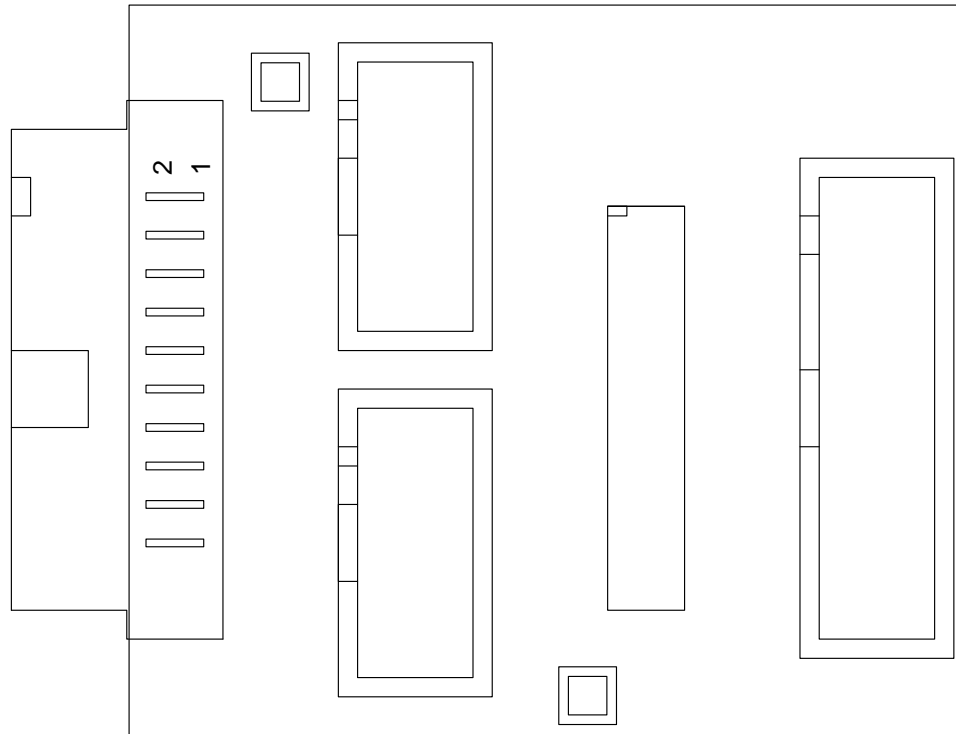

CONTENTS	PAGE
Root Schema fpga4umubus	2
Xref fpga4umubus	3
Drill	4
Etch	5
Outline_Top	6
Gerber_mtop	7
Gerber_top	8
Gerber_bot	9
Gerber_mbot	10
Gerber_cont	11
Component Report	12
BOM Report	13
NC-Pins Report	14
Power-Pins Report	15

CONTENTS	PAGE
Single Node Nets	16

Connexion to FPGA4U 20 pins

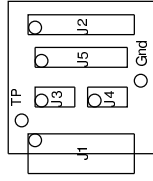
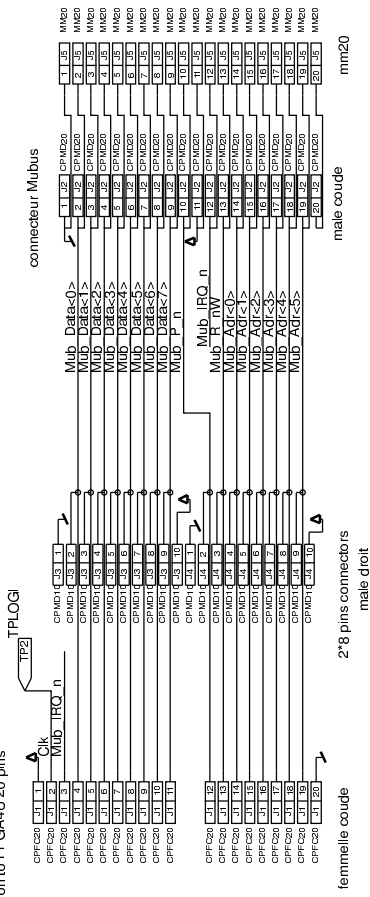

○ = pin 1

DRAWING	ENGINEER:
FPGA4UMIBUS	R.Beuchat
DATE:	PAGE: 1/1
Mon Dec 4 14:55:39 2006	acort cuser

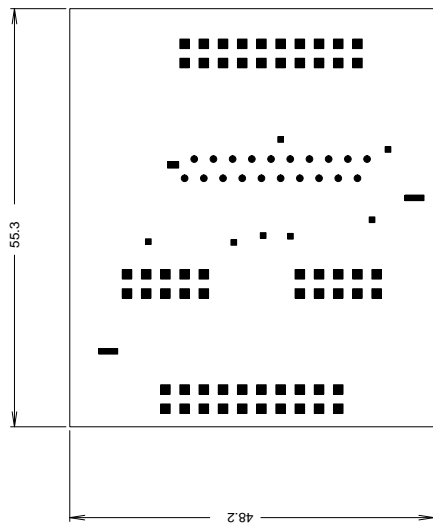

DRILL CHART			
FIGURE	SIZE	PLATED	QTY
•	0.401	PLATED	7
•	0.787	PLATED	20
■	0.889	PLATED	60
■	0.94	PLATED	2
■	1.499	PLATED	1

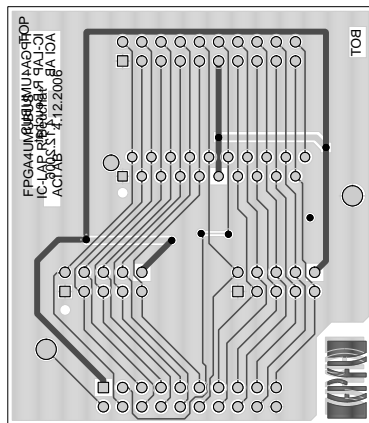

TITRE:FPGA4UMUBUS

LABORATOIRE:IC-LAP
ENGINEER:R.Beuchat

DATE:4.12.2006
EPFL-ACORT-AB

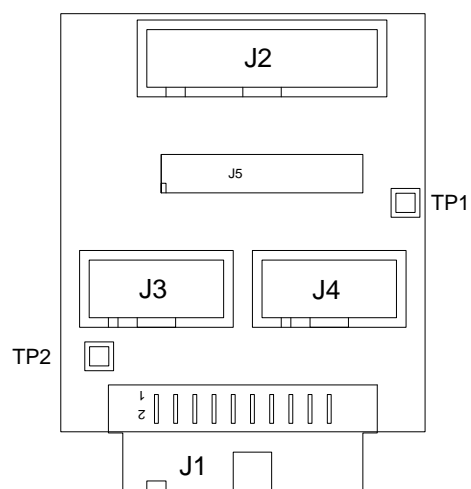

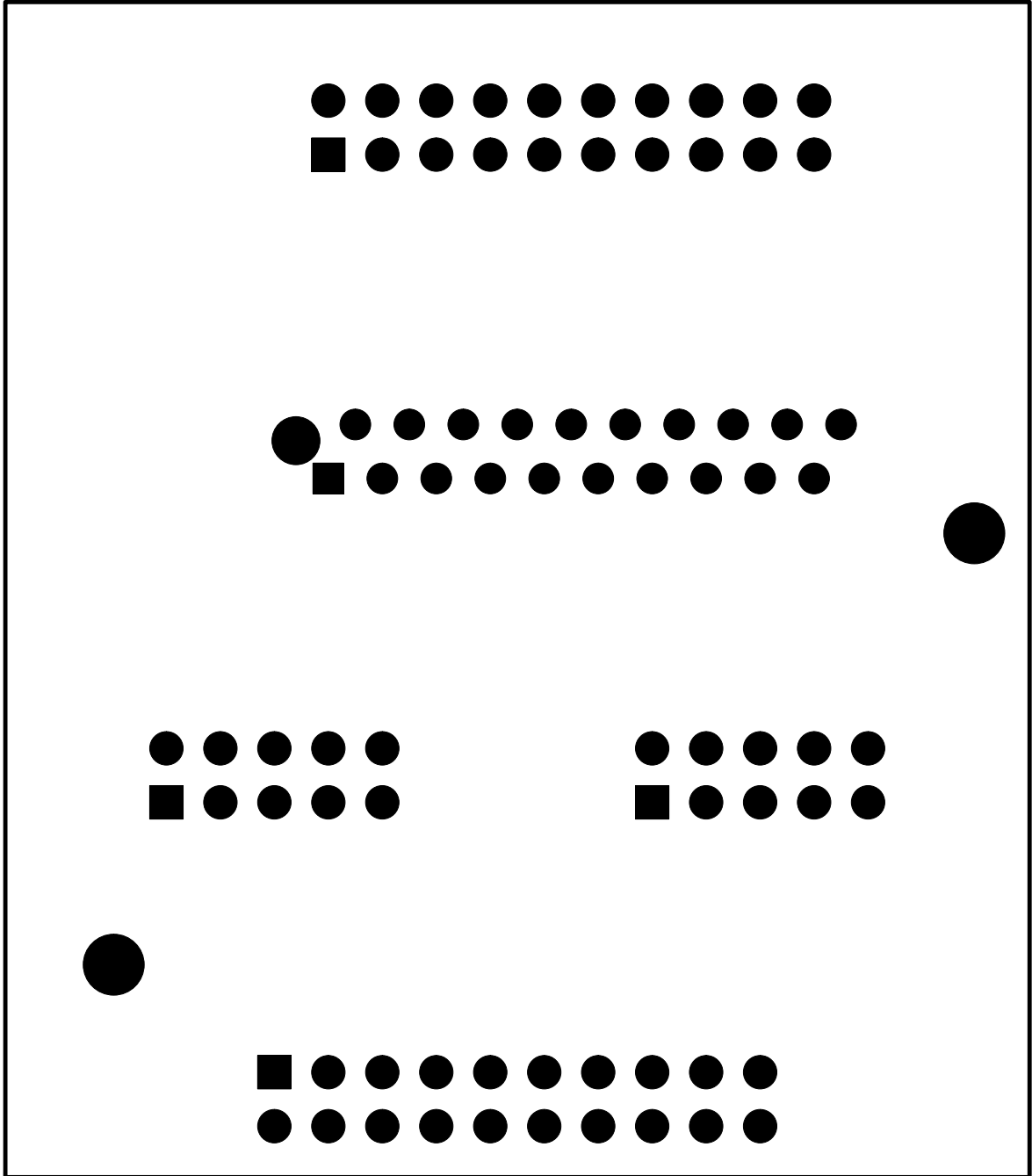

TOP
FPGA4UMUBUS
IC-LAP R.Beuchat
ACI AB 4.12.2006

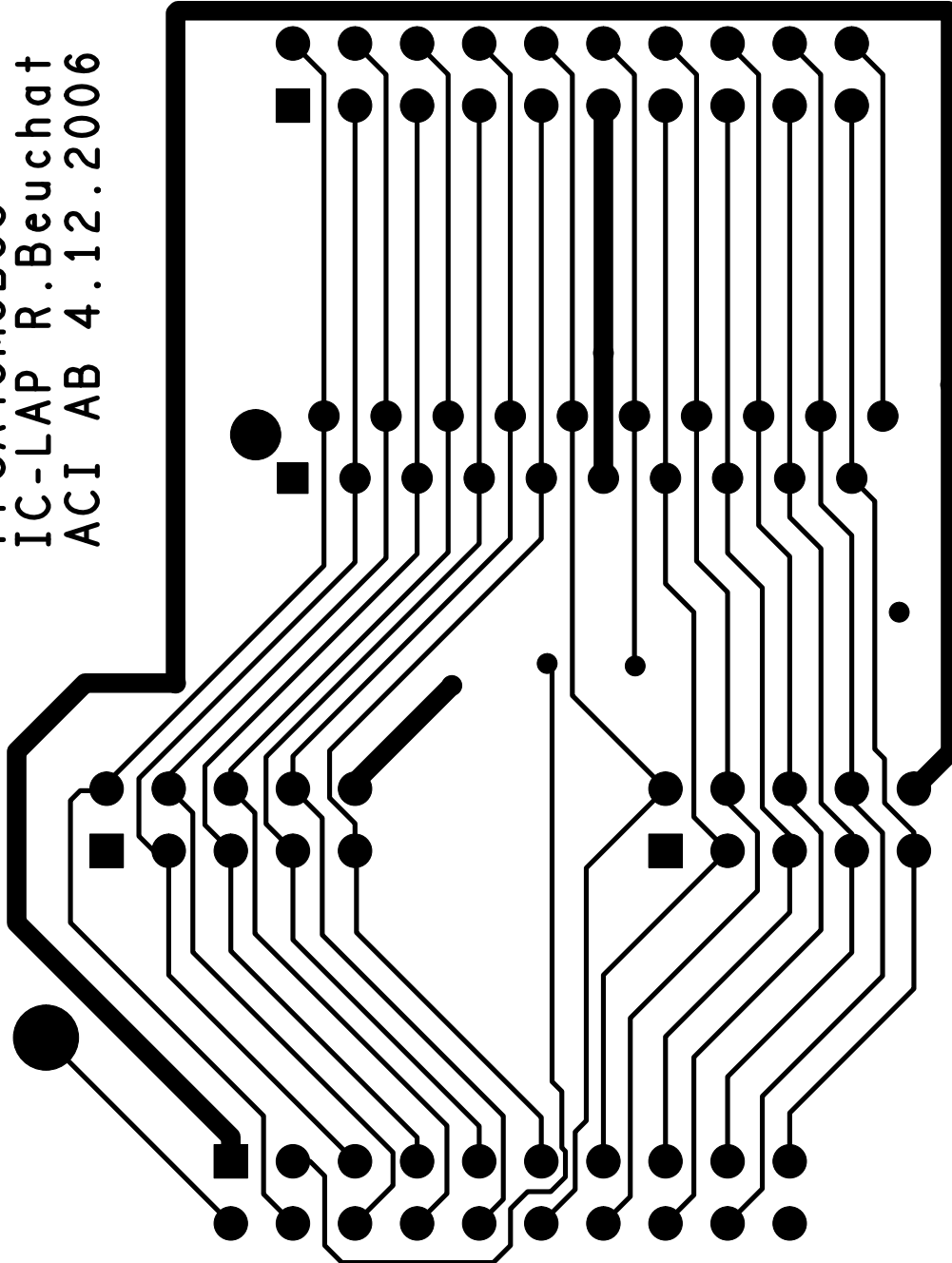

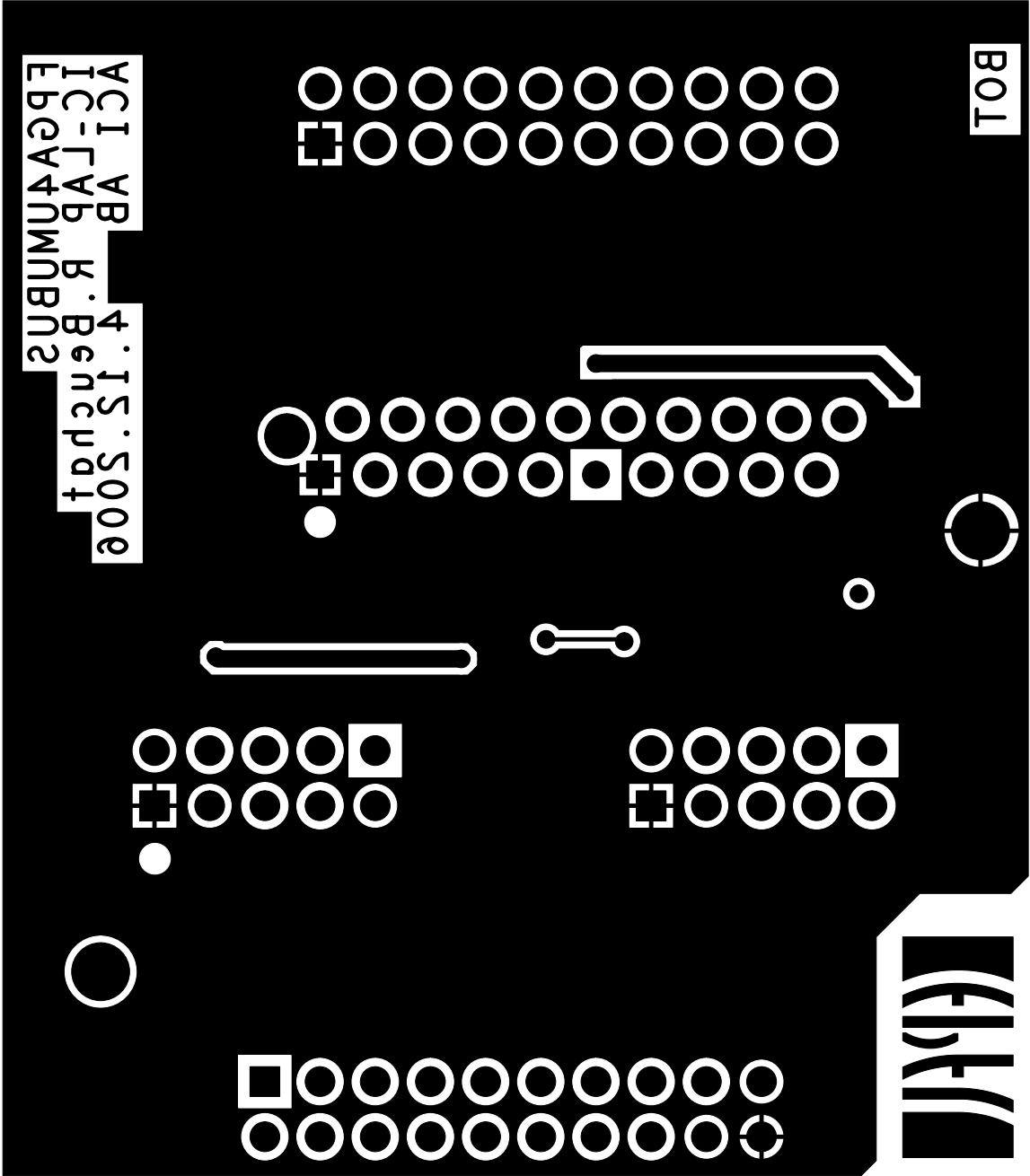

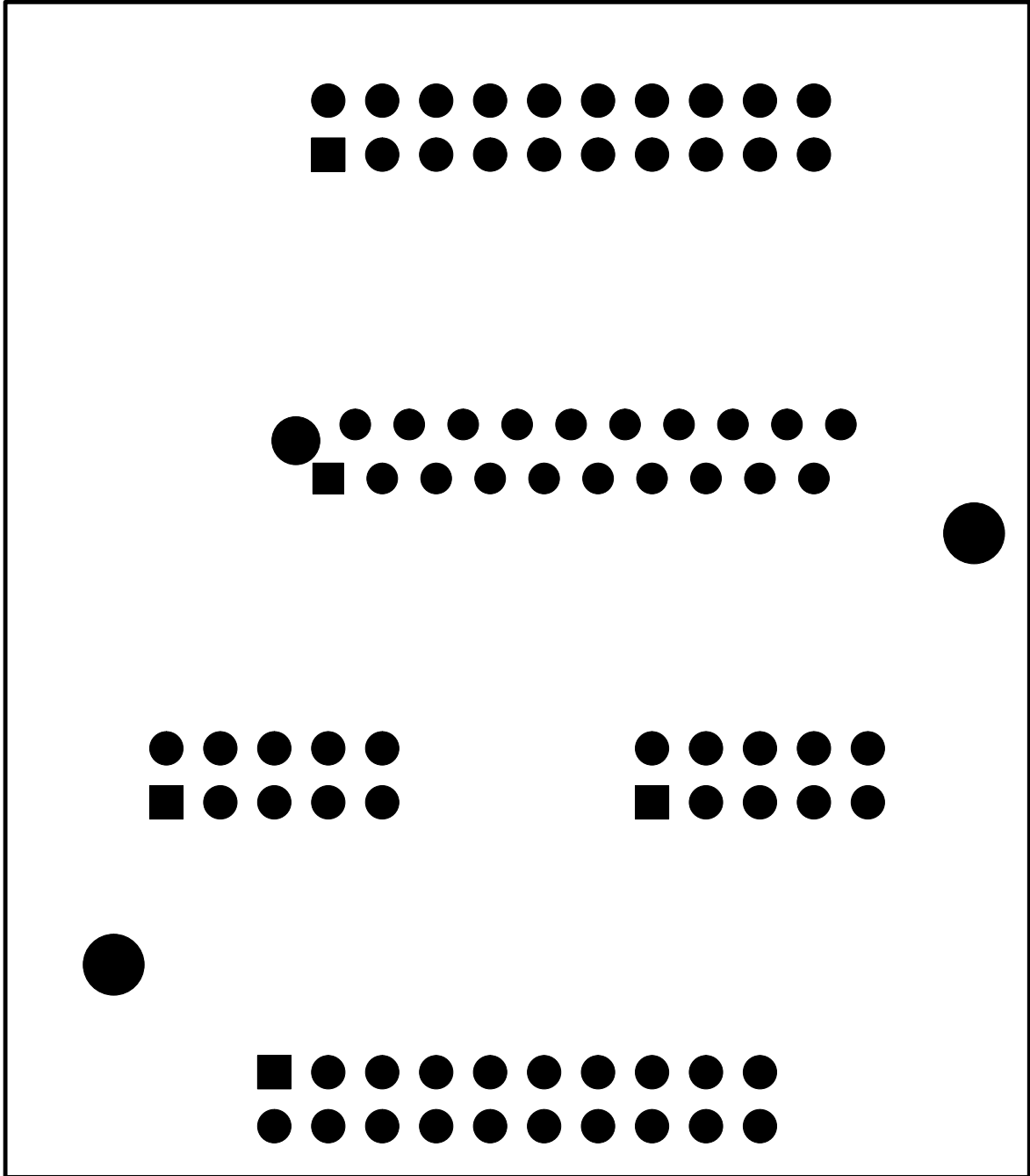

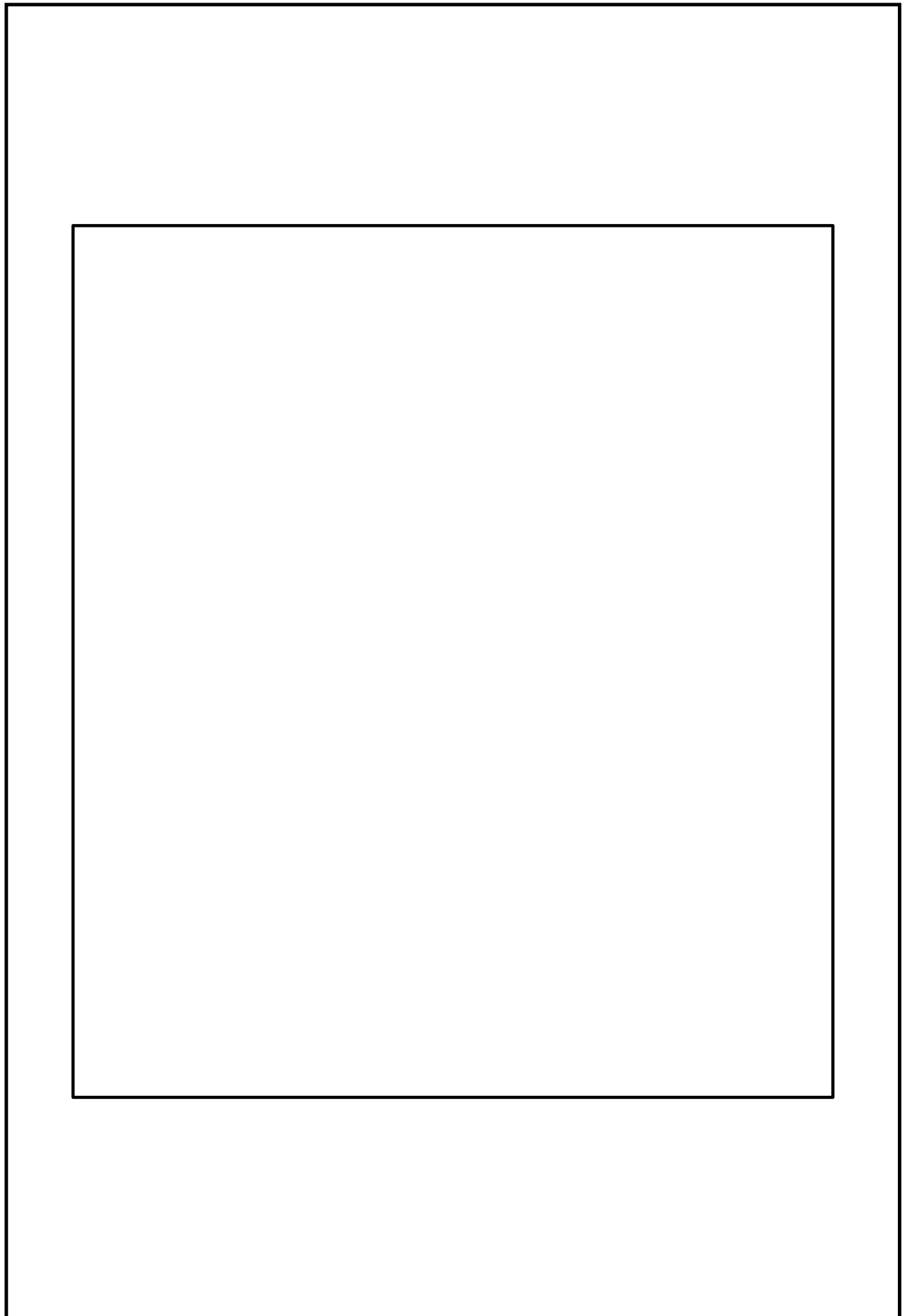

Component Report FPGA4UMUBUS

fpga4umubus_gloss

Fri Dec 8 15:17:01 MET 2006

Ref Des	Device Type	Value	Package Type	x	y	ang	Mir	Remark
J1	CO20		CPFC20	-22.860	5.080	90.000	NO	
J2	CO20		CPMD20	20.320	25.400	270.000	NO	
J3	CO10		CPMD10	-10.160	33.020	270.000	NO	
J4	CO10		CPMD10	-10.160	10.160	270.000	NO	
J5	CO20		MM20	5.080	25.400	270.000	NO	
TP1	TP		TPLOGI	2.500	-5.000	0.000	NO	
TP2	TP		TPLOGI	-17.800	35.500	0.000	NO	

Total Component count 7

BOM Report FPGA4UMUBUS

fpga4umubus_gloss

Fri Dec 8 15:17:02 MET 2006

Device	Package	Value	Nb	Reference Designators	Remark
CO10-CPMD10	CPMD10		2	J3 J4	
CO20-CPFC20	CPFC20		1	J1	
CO20-CPMD20	CPMD20		1	J2	
CO20-MM20	MM20		1	J5	
TP-4	TPLOGI		2	TP1 TP2	

Total Component count 7

NC Pins Report FPGA4UMUBUS

fpga4umubus_gloss

Fri Dec 8 15:17:02 MET 2006

Ref Des	Device	Nb	Not Connected Pins	Remark
0		0		

Total count 0

Power Pins Report FPGA4UMUBUS

fpga4umubus_gloss

Fri Dec 8 15:17:03 MET 2006

Ref Des	Device	Name	Power Pins	Remark
J1	CO20-CPFC20	GND	20	
		VCC	1	
J2	CO20-CPMD20	GND	1	
		VCC	11	
J3	CO10-CPMD10	GND	1	
		VCC	10	
J4	CO10-CPMD10	GND	1	
		VCC	10	
J5	CO20-MM20	GND	1	
		VCC	11	
TP1	TP-4	GND	1	

Total count 6

Single Node Nets Report FPGA4UMUBUS

fpga4umubus_gloss

Fri Dec 8 15:17:03 MET 2006

Netname	Node	Device	Remark
---------	------	--------	--------

Total Nets count 0