

EXTCLDPATCH

LAP R.Beuchat
Phone: +41 21 693 3903
Mon Nov 10 15:32:32 MET 2008

MFG_DATE: 10.11.2008
QUANTITY: 2
SOLDERMASK: mtop mbot
MATERIAL: FR4 : 0.8 mm

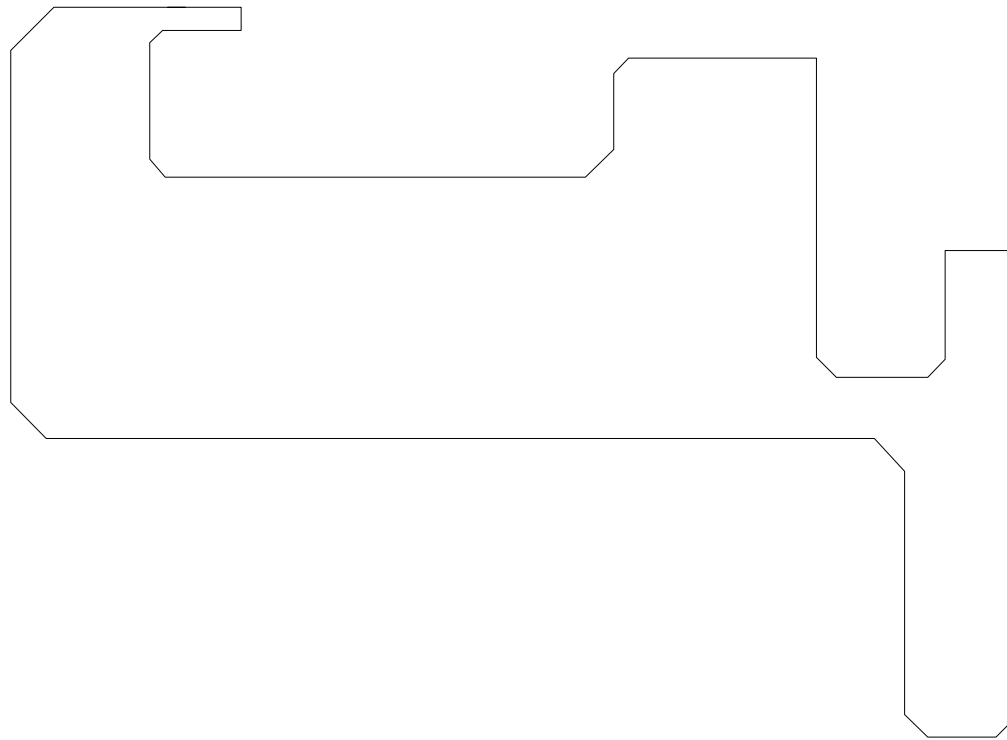

CONTENTS	PAGE
Root Schema extclpatch	2
Xref extclpatch	3
Drill	4
Etch	5
Outline_Bottom	6
Outline_Top	7
Gerber_mtop	8
Gerber_top	9
Gerber_bot	10
Gerber_mbot	11
Gerber_cont	12
Component Report	13
BOM Report	14
NC-Pins Report	15

CONTENTS	PAGE
Power-Pins Report	16
Single Node Nets	17

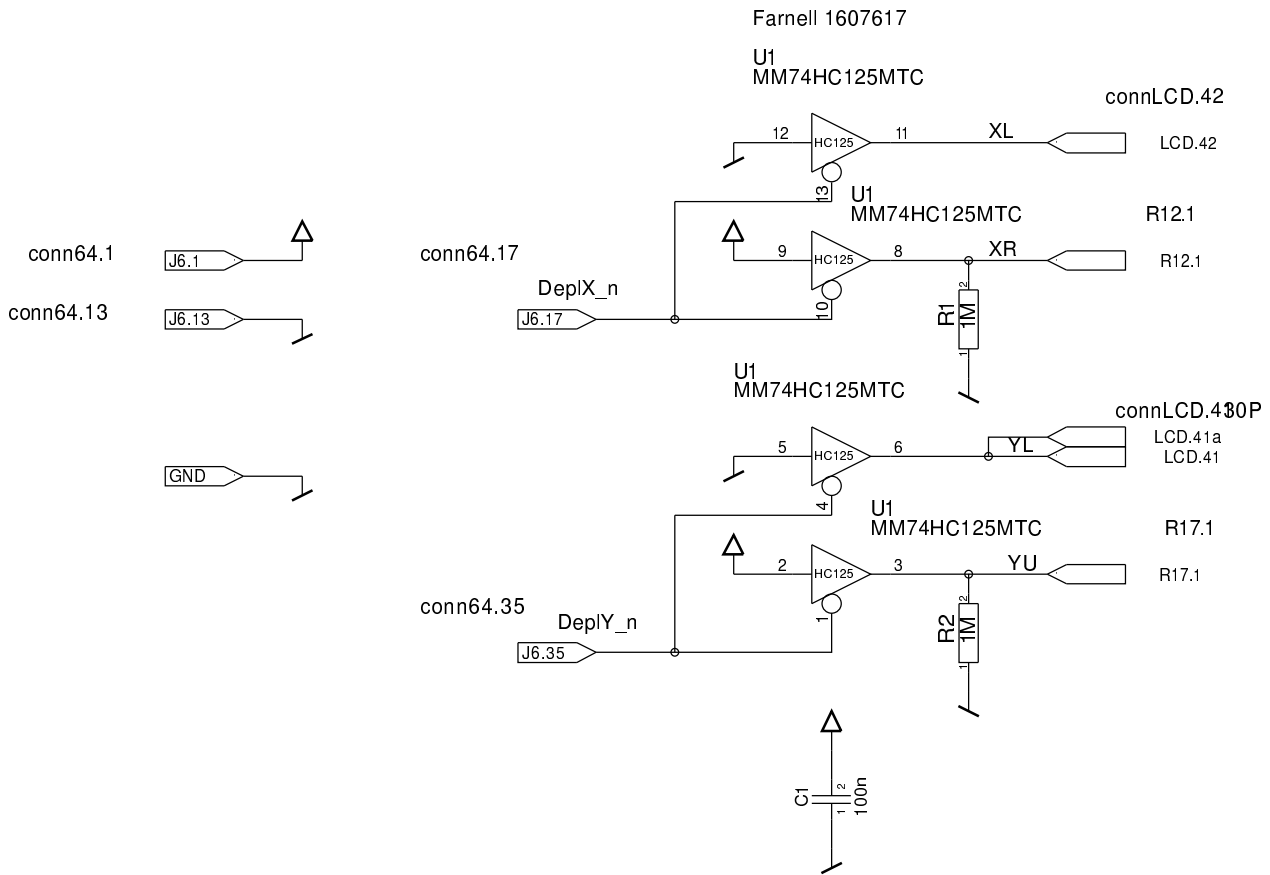

Attention aux composants de la carte extlcd BOTTOM !!

connLCD 45 pins

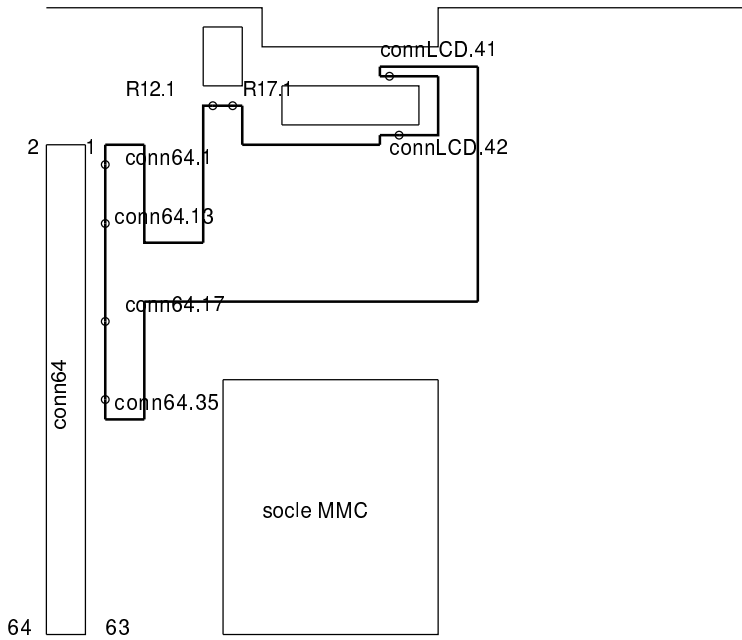

DRAWING EXTCLDPATCH	ENGINEER:
DATE: Mon Nov 10 15:09:35 2008	PAGE: 1/1 acort cuser

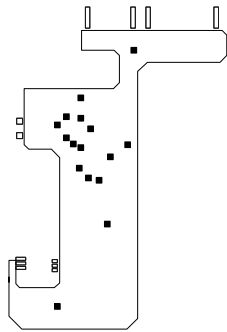

DRILL CHART			
FIGURE	SIZE	PLATED	QTY
▪	0.401	PLATED	16

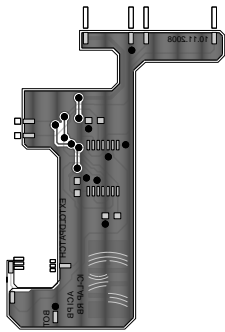

TITRE:EXTCLDPATCH

LABORATOIRE:IC-LAP
ENGINEER:R.Beuchat

DATE:10.11.2008
EPFL-ACORT-PB

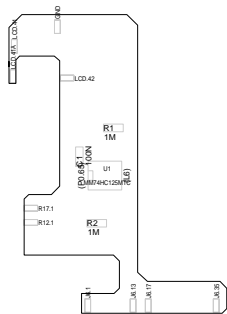

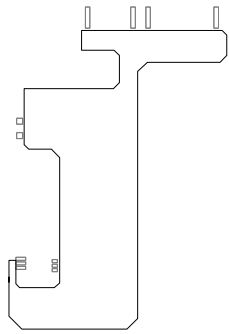

TITRE:EXTCLDPATCH

LABORATOIRE:IC-LAP
ENGINEER:R.Beuchat

DATE:10.11.2008
EPFL-ACORT-PB

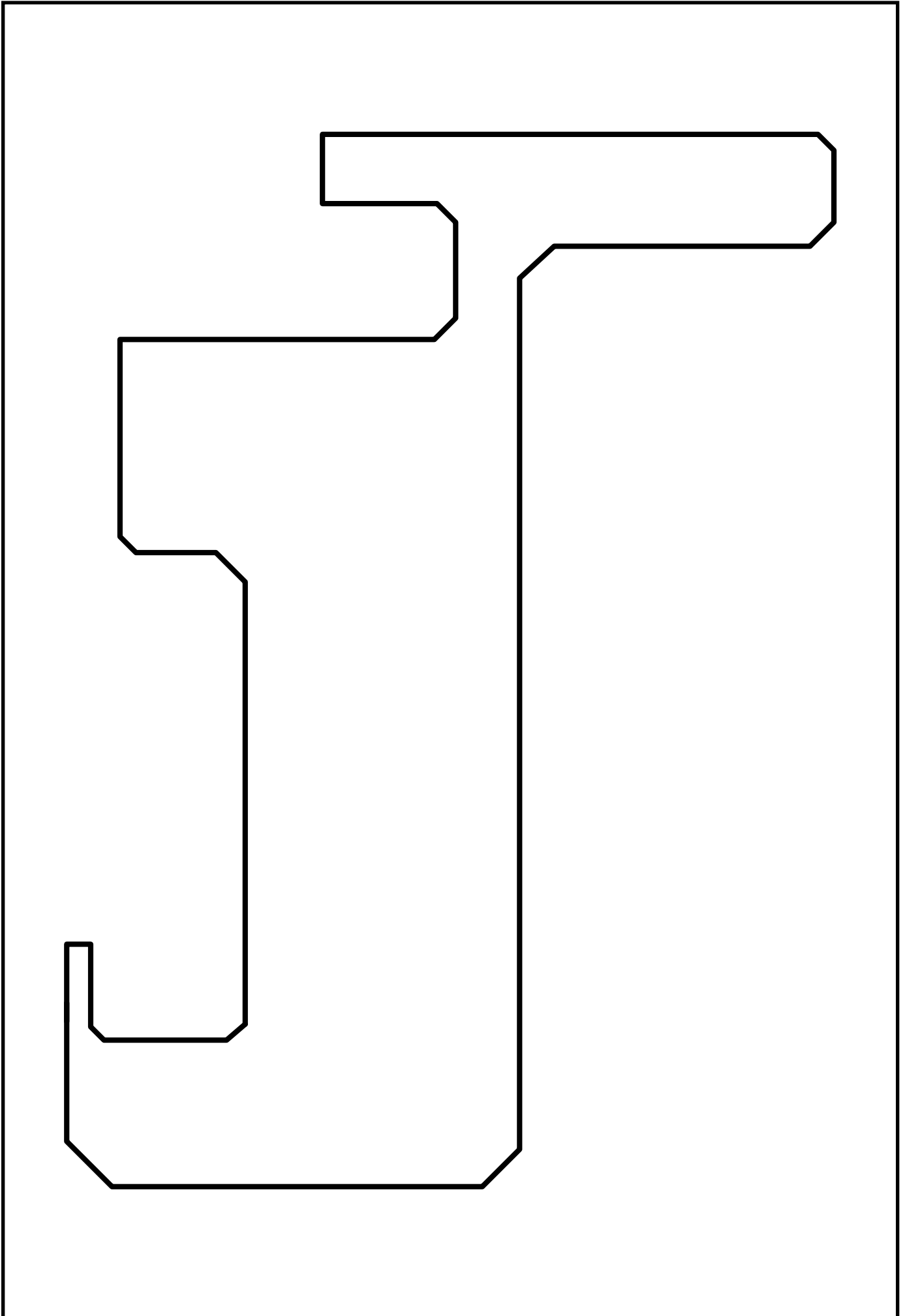

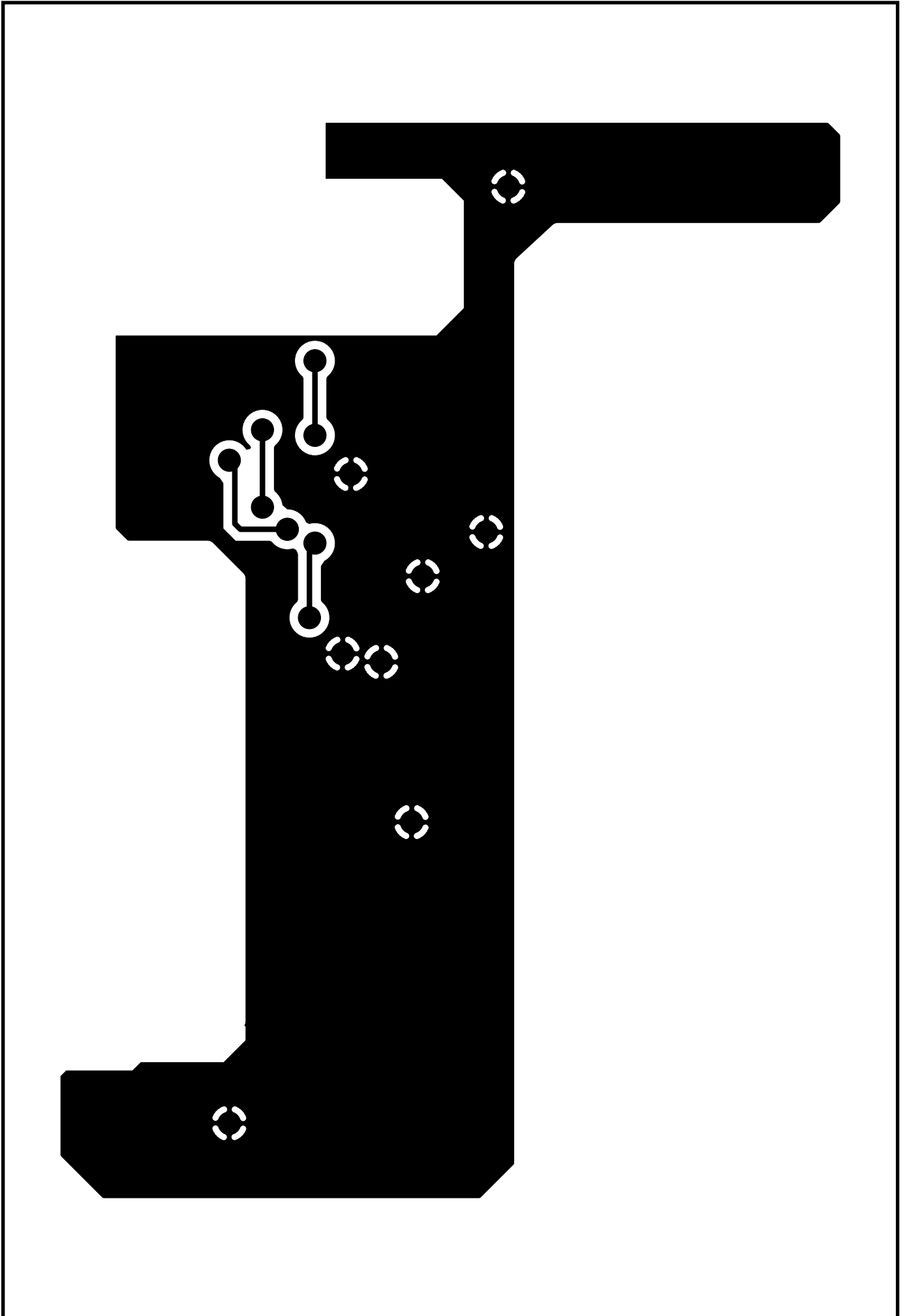

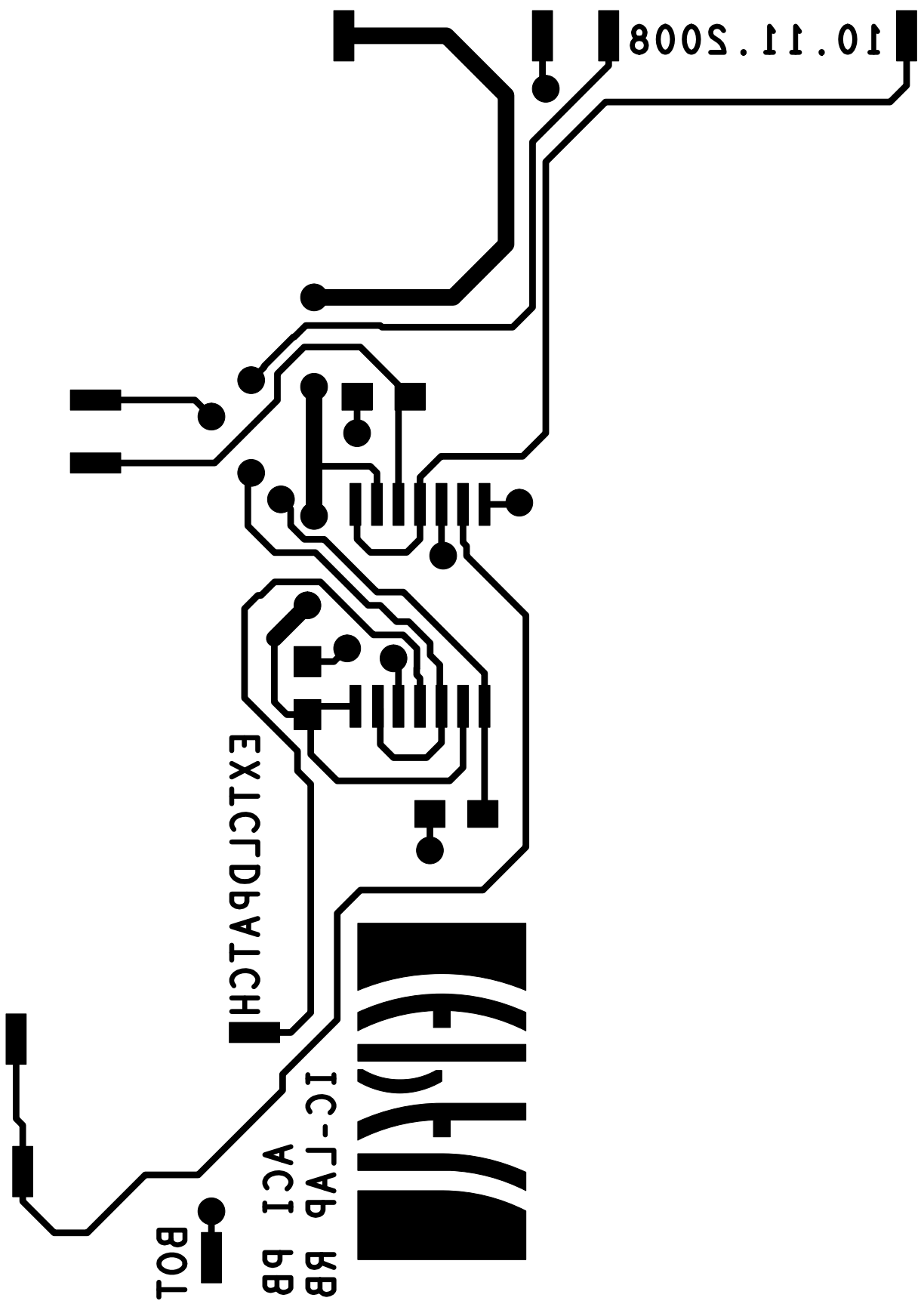

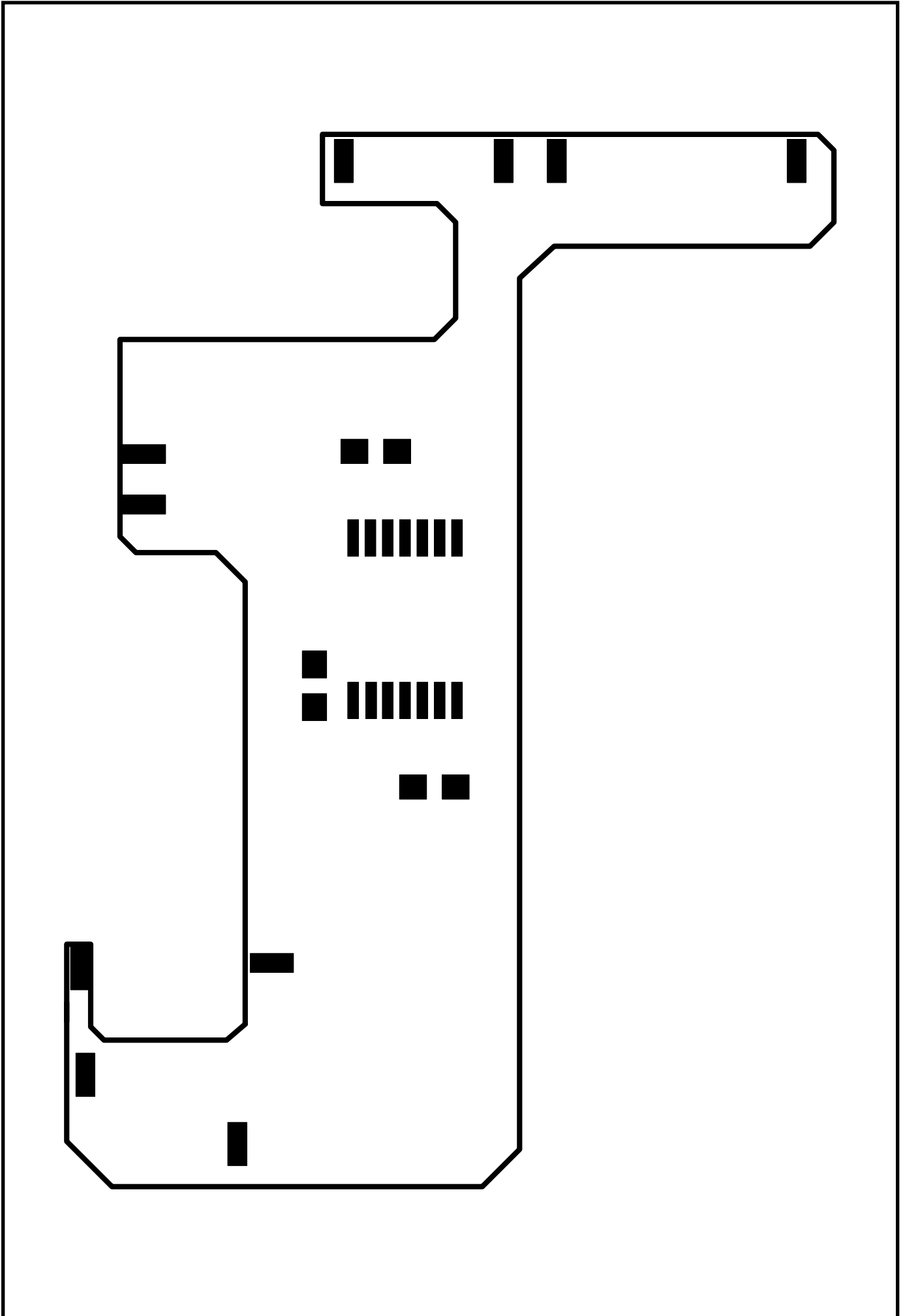

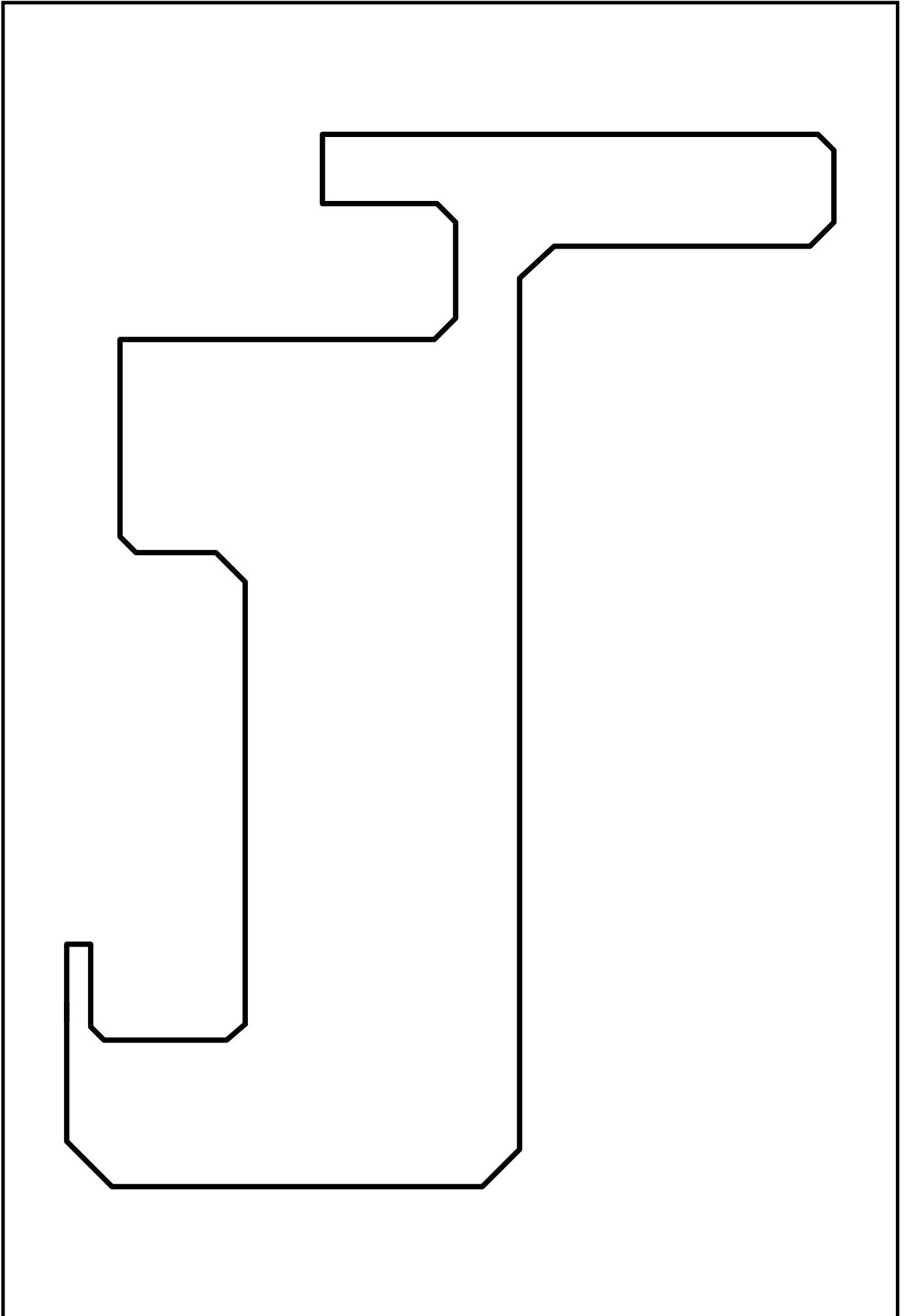

Component Report EXTCLDPATCH

extlcdpatch_gloss

Mon Nov 10 15:32:34 MET 2008

Ref Des	Device Type	Value	Package Type	x	y	ang	Mir	Remark
C1	0603	100N	0603	43.200	46.600	270.000	YES	
GND	TP		TPSMD	26.000	49.500	0.000	YES	
J6.1	TP		TPSMD	62.900	45.500	0.000	YES	
J6.13	TP		TPSMD	62.900	39.500	0.000	YES	
J6.17	TP		TPSMD	62.900	37.500	0.000	YES	
J6.35	TP		TPSMD	62.900	28.500	0.000	YES	
LCD.41	TP		TPSMD	28.600	55.200	0.000	YES	
LCD.42	TP		TPSMD	32.800	48.200	90.000	YES	
LCD.41A	TP		TPSMD	32.600	55.400	0.000	YES	
R1	R	1M	0603	39.400	42.100	0.000	YES	
R2	R	1M	0603	52.000	44.300	0.000	YES	
R12.1	TP		TPSMD	51.900	53.000	90.000	YES	
R17.1	TP		TPSMD	50.000	53.000	90.000	YES	
U1	MM74HC125MTC		TSSOP14	45.700	43.200	0.000	YES	

Total Component count 14

BOM Report EXTCLDPATCH

extlcdpatch_gloss

Mon Nov 10 15:33:04 MET 2008

Device	Package	Value	Nb	Reference Designators	Remark
0603-100N	0603	100N	1	C1	
MM74HC125MTC	TSSOP14		1	U1	
R-0603-1M	0603	1M	2	R1 R2	
TP-TPSMD	TPSMD		10	GND J6.1 J6.13 J6.17 J6.35 LCD.41 LCD.42 LCD.41A R12.1 R17.1	

Total Component count 14

NC Pins Report EXTCLDPATCH

extlcdpatch_gloss

Mon Nov 10 15:33:05 MET 2008

Ref Des	Device	Nb	Not Connected Pins	Remark
0		0		

Total count 0

Power Pins Report EXTCLDPATCH

extlcdpatch_gloss

Mon Nov 10 15:33:05 MET 2008

Ref Des	Device	Name	Power Pins			Remark
GND	TP-TPSMD	GND	1			
J6.1	TP-TPSMD	VCC	1			
J6.13	TP-TPSMD	GND	1			
U1	MM74HC125MTC	GND	5	7	12	
		VCC	2	9	14	

Total count 4

Single Node Nets Report EXTCLDPATCH

extlcdpatch_gloss

Mon Nov 10 15:33:06 MET 2008

Netname	Node	Device	Remark
---------	------	--------	--------

Total Nets count 0